

IQ2000VXS AND IQ2400VXS SPEC DRAWINGS REV 1

IQ2000VXS

COOLING CAPACITY: 2000 BTUH @131°F
 MAXIMUM AMPS: 6.6 @120V/60HZ
 MAXIMUM AMPS: 3.4/3.8 @230/220 60/50HZ
 MAXIMUM OPERATING TEMP.: 131°F
 DIMENSIONS: 24.00"H X 10.00"W X 10.00"D
 WEIGHT: 60 LBS

IQ2400VXS

COOLING CAPACITY: 2400 BTUH @131°F
 MAXIMUM AMPS: 7.1 @120V/60HZ
 MAXIMUM AMPS: 3.5/3.9 @230/220 60/50HZ
 MAXIMUM OPERATING TEMP.: 131°F
 DIMENSIONS: 24.00"H X 10.00"W X 10.00"D
 WEIGHT: 60 LBS

IQ2000VXS
 IQ2400VXS
 TOP VIEW

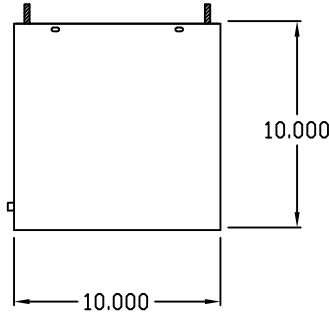

IQ2000VXS
 IQ2400VXS
 LEFT SIDE

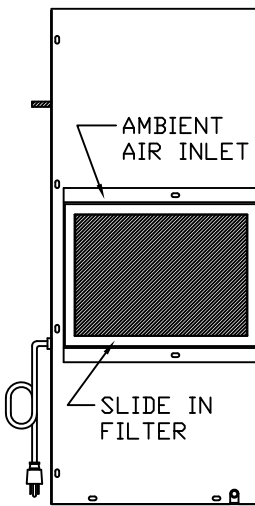

IQ2000VXS
 IQ2400VXS
 FRONT VIEW

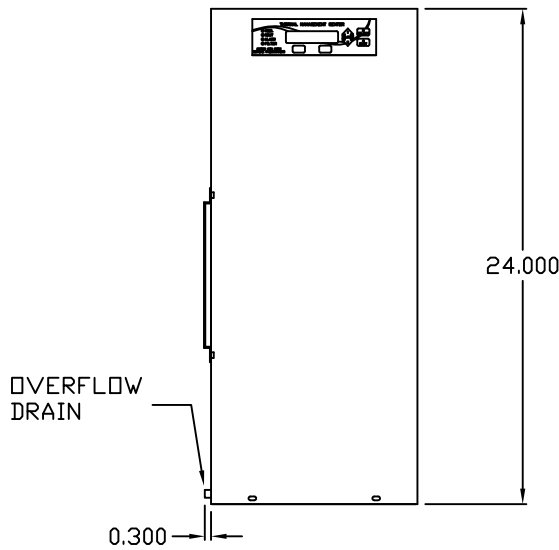

IQ2000VXS
 IQ2400VXS
 RIGHT SIDE

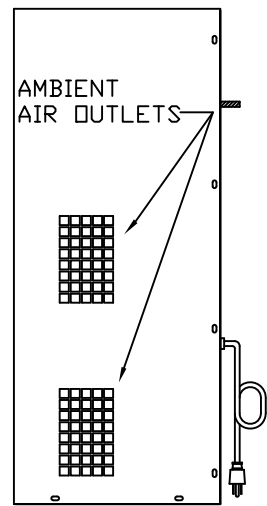

PROPRIETARY DRAWING
 THIS DRAWING IS THE PROPERTY OF ICE
 QUBE, INC. AND IS NOT TO BE REPLICATED
 OR ALTERED WITHOUT AUTHORIZATION OF
 ICE QUBE, INC.

DRAWN: GFD SCALE: NONE
 DATE: 4-20-05
 SHEET 2 OF 2

Ice Qube INDUSTRIAL COOLING EQUIPMENT
 141 WILSON AVENUE
 GREENSBURG, PA 15601
 724-837-8204 • 1-888-867-8234
 FAX: 724-837-3286

IQ20/2400VXS
 IQ280205 | 1

IQ2000VXS
 IQ2400VXS
 REAR VIEW

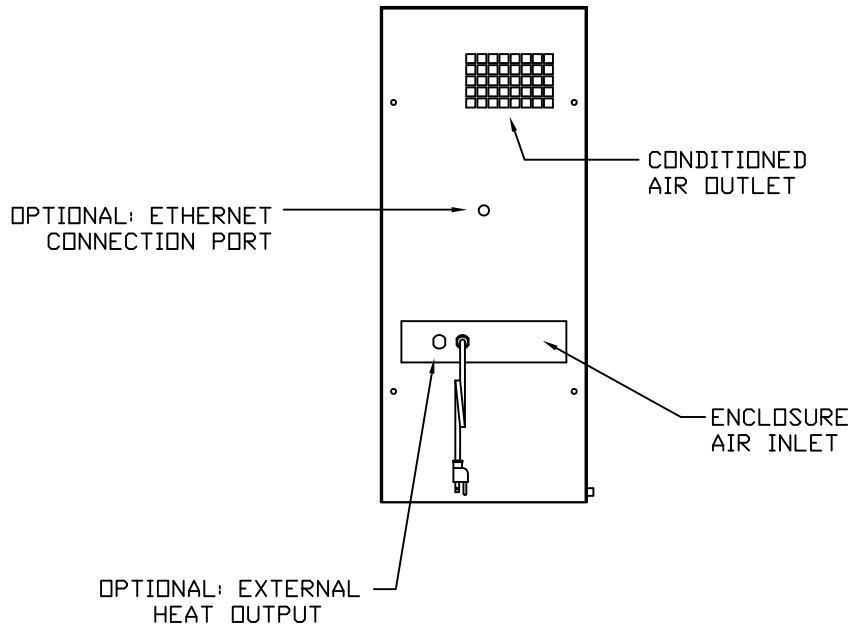

IQ2000VXS
 IQ2400VXS
 CUTOUT DRAWING

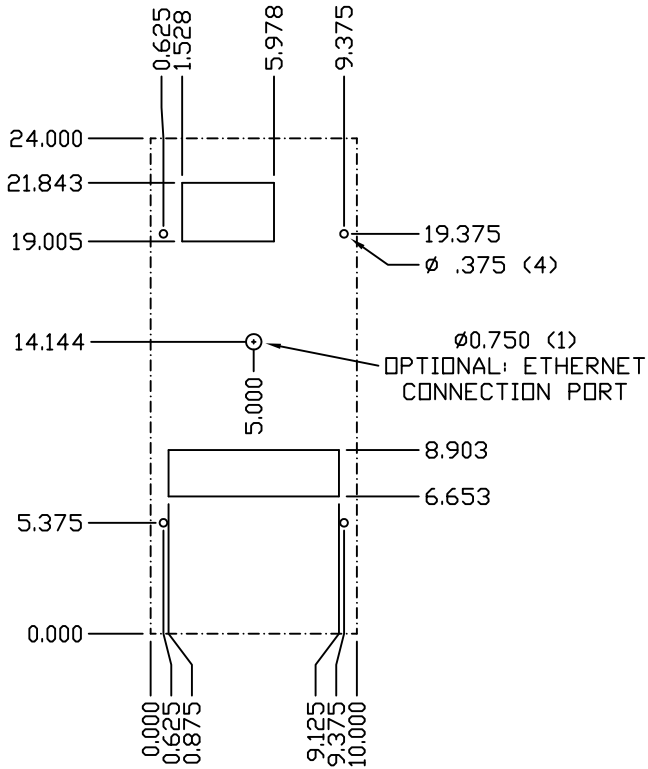

IQ2000VXS
 IQ2400VXS
 GASKET DRAWING

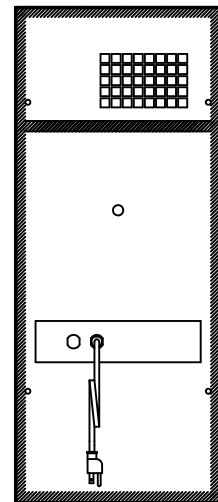

GASKET MUST BE APPLIED AS SHOWN FOR PROPER OPERATION AND TO MAINTAIN NEMA INTEGRITY

1	ADDED REV LEVEL AND DRAWING # BLOCK UPDATED SPECS AND VIEWS	2-20-08	JJH
0	INITIAL RELEASE	4-20-05	GFD
REV	DESCRIPTION	DATE	CHECKED
	REVISIONS		

PROPRIETARY DRAWING
 THIS DRAWING IS THE PROPERTY OF ICE
 GULF, INC. AND IS NOT TO BE REPLICATED
 OR ALTERED WITHOUT AUTHORIZATION OF
 ICE GULF, INC.

DRAWN GFD SCALE NONE
 DATE 4-20-05
 SHEET 1 OF 2

	INDUSTRIAL COOLING EQUIPMENT 141 WILSON AVENUE GREENSBURG, PA 15601 724-837-8204 • 1-888-867-8234 FAX 724-837-3286	
	IQ20/2400VXS IQ280205	1