

OD Series

OD-50DDXC



Why Choose the OD Series?

The OD series of enclosures are the ultimate choice for your outdoor racking requirements. Being made of our own rugged Alumiflex®, you'll find it noticeably lighter than steel, yet strong enough to rack even the heaviest equipment. When choosing the OD series, you have handpicked the highest value in American construction. The OD-50DDXC includes the standard features you have come to expect with DDB, incorporating the versatile strut system for adjustable racking, the security of a 3-point locking system and our patented Alumishield® solar cap to manage heat loads. For those who need more than just our standard enclosure, DDB can also make a truly customized solution with our many available options including HVAC, providing a climate-controlled environment for any electronic equipment, electrical load panels and cable entry solutions to name a few. All of this comes together to create an enclosure able to meet all of the unique needs our customers have been seeking. DDB offers a state-of-the-art design, a competitive price, benchmark lead times and a guaranteed delivery, all backed up with an industry leading 15-year warranty on every enclosure. Put DDB's substantial stock to work for you today. Contact our professional staff to assist you with your made-to-order solution.



Features

- 0.125" Aluminum Construction
- Stainless Steel External Hardware/Hinge
- 3 Point Lock System
- Heavy Duty Out-Door Construction
- Front and Rear Access
- Custom Colors Available
- Cream and Red Powder-Coat in Stock
- Flexible and Scalable
- 15 Year Warranty
- Quick Shipping

Application Types

- Telecommunications
- Wireless/Broadband
- Fiber Optics
- Back Haul
- Small Cell/DAS
- Public Safety
- Utility
- Base Station
- Military
- Trailer-Based Communications
- Wi-Fi
- LTEE/4G/5G



Industry Standards:

- NEMA 3R as shown
- NEMA 4 and 4X configurable (unlisted to environmental rating)
- OD Series Listed to UL 50/50E Type 4 Available**
- ETL listed to UL Standard 60950-1/CSA 22.2C

2301 S. HWY 77 Pauls Valley, OK 73075

T: (800) 753-8459 – F: (877) 220-7236

sales@ddbunlimited.com www.ddbunlimited.com

Weight and Dimensions

Approximate Exterior Enclosure Dimensions:

51"H x 28"W x 47"D

Shipping Dimensions:

32"W x 52"L - Palletized

Approximate Shipping Weight:

227 lbs.

OD Series

OD-50DDXC



Features

1. Solar Shield (Alumishield)
2. Front and Rear 19" Adjustable Racking Rails
3. Rear Access Door
4. Stainless Steel Door Hinge
5. 3 Point Locking System
6. Powder-Coat Cream
7. Reusable Vent Filters

2301 S. HWY 77 Pauls Valley, OK 73075

T: (800) 753-8459 – F: (877) 220-7236

sales@ddbunlimited.com www.ddbunlimited.com

WEB DRAWING (NOT FOR FABRICATION)

REVISIONS		
REV.	DESCRIPTION	DATE
A	Web Drawing per DR-00425	11/15/2011
B	Add new components and DWG template to WEB DWG per DR-00922	5/12/2014
C	UPDATED TO 2019 FORMAT	3/1/2019

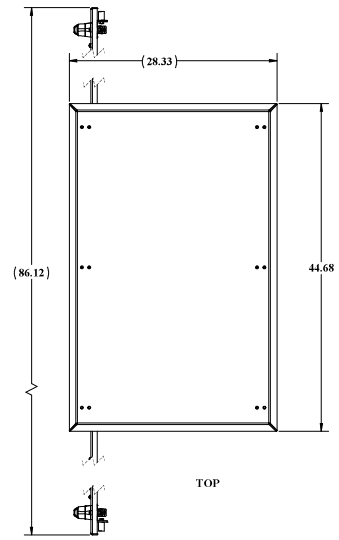

STANDOFFS STANDARD FOR OPTIONAL LIGHTING OVER EACH DOOR FRONT AND REAR

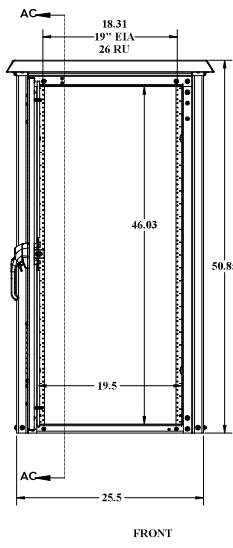
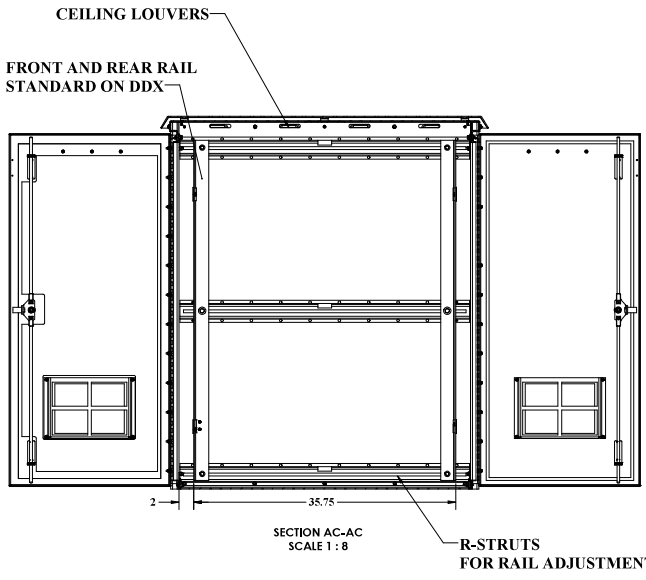
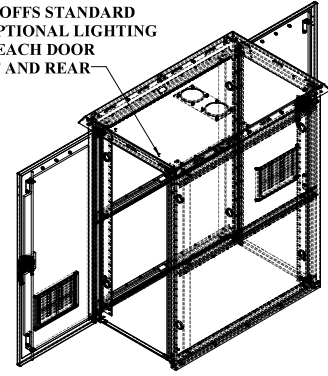

3 POINT LOCKING EACH DOOR

FILTERED LOUVERS

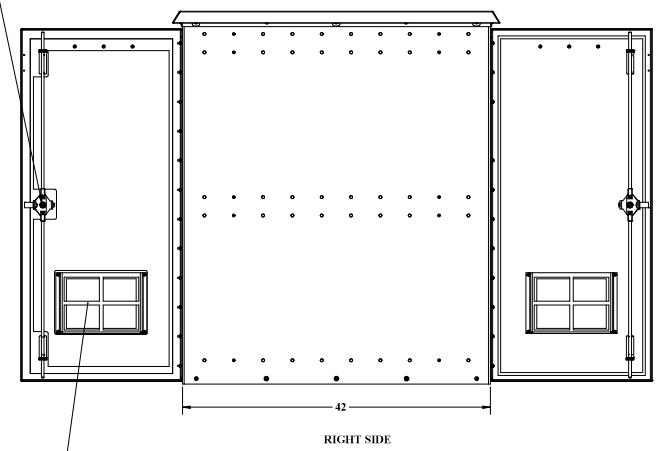

WEB DRAWING (NOT FOR FABRICATION)

UNLESS OTHERWISE SPECIFIED:		NAME	DATE	DDB Unlimited Inc.		
DESCRIPTION AND QUANTITY	Model No.	0008	03-22-24	OD Family Endusers		
ARTICLE NO.	Drawn By	MacVas	09-04-19	Echelon - OD, 96, DDX		
REV. DESCRIPTION	DATE					
REV. 1	03-22-24					
REV. 2	03-22-24					
REV. 3	03-22-24					
REV. 4	03-22-24					
REV. 5	03-22-24					
REV. 6	03-22-24					
REV. 7	03-22-24					
REV. 8	03-22-24					
REV. 9	03-22-24					
REV. 10	03-22-24					
REV. 11	03-22-24					
REV. 12	03-22-24					
REV. 13	03-22-24					
REV. 14	03-22-24					
REV. 15	03-22-24					
REV. 16	03-22-24					
REV. 17	03-22-24					
REV. 18	03-22-24					
REV. 19	03-22-24					
REV. 20	03-22-24					
REV. 21	03-22-24					
REV. 22	03-22-24					
REV. 23	03-22-24					
REV. 24	03-22-24					
REV. 25	03-22-24					
REV. 26	03-22-24					
REV. 27	03-22-24					
REV. 28	03-22-24					
REV. 29	03-22-24					
REV. 30	03-22-24					
REV. 31	03-22-24					
REV. 32	03-22-24					
REV. 33	03-22-24					
REV. 34	03-22-24					
REV. 35	03-22-24					
REV. 36	03-22-24					
REV. 37	03-22-24					
REV. 38	03-22-24					
REV. 39	03-22-24					
REV. 40	03-22-24					
REV. 41	03-22-24					
REV. 42	03-22-24					
REV. 43	03-22-24					
REV. 44	03-22-24					
REV. 45	03-22-24					
REV. 46	03-22-24					
REV. 47	03-22-24					
REV. 48	03-22-24					
REV. 49	03-22-24					
REV. 50	03-22-24					
REV. 51	03-22-24					
REV. 52	03-22-24					
REV. 53	03-22-24					
REV. 54	03-22-24					
REV. 55	03-22-24					
REV. 56	03-22-24					
REV. 57	03-22-24					
REV. 58	03-22-24					
REV. 59	03-22-24					
REV. 60	03-22-24					
REV. 61	03-22-24					
REV. 62	03-22-24					
REV. 63	03-22-24					
REV. 64	03-22-24					
REV. 65	03-22-24					
REV. 66	03-22-24					
REV. 67	03-22-24					
REV. 68	03-22-24					
REV. 69	03-22-24					
REV. 70	03-22-24					
REV. 71	03-22-24					
REV. 72	03-22-24					
REV. 73	03-22-24					
REV. 74	03-22-24					
REV. 75	03-22-24					
REV. 76	03-22-24					
REV. 77	03-22-24					
REV. 78	03-22-24					
REV. 79	03-22-24					
REV. 80	03-22-24					
REV. 81	03-22-24					
REV. 82	03-22-24					
REV. 83	03-22-24					
REV. 84	03-22-24					
REV. 85	03-22-24					
REV. 86	03-22-24					
REV. 87	03-22-24					
REV. 88	03-22-24					
REV. 89	03-22-24					
REV. 90	03-22-24					
REV. 91	03-22-24					
REV. 92	03-22-24					
REV. 93	03-22-24					
REV. 94	03-22-24					
REV. 95	03-22-24					
REV. 96	03-22-24					
REV. 97	03-22-24					
REV. 98	03-22-24					
REV. 99	03-22-24					
REV. 100	03-22-24					

DDB FORM 7.1.2 REV F 02/11/19

THE INFORMATION CONTAINED IN THIS DRAWING IS THE SOLE PROPERTY OF DDB Unlimited, INC. ANY REPRODUCTION IN PART OR AS A WHOLE WITHOUT THE WRITTEN PERMISSION OF DDB Unlimited, INC. IS PROHIBITED.

WEB DRAWING (NOT FOR FABRICATION)

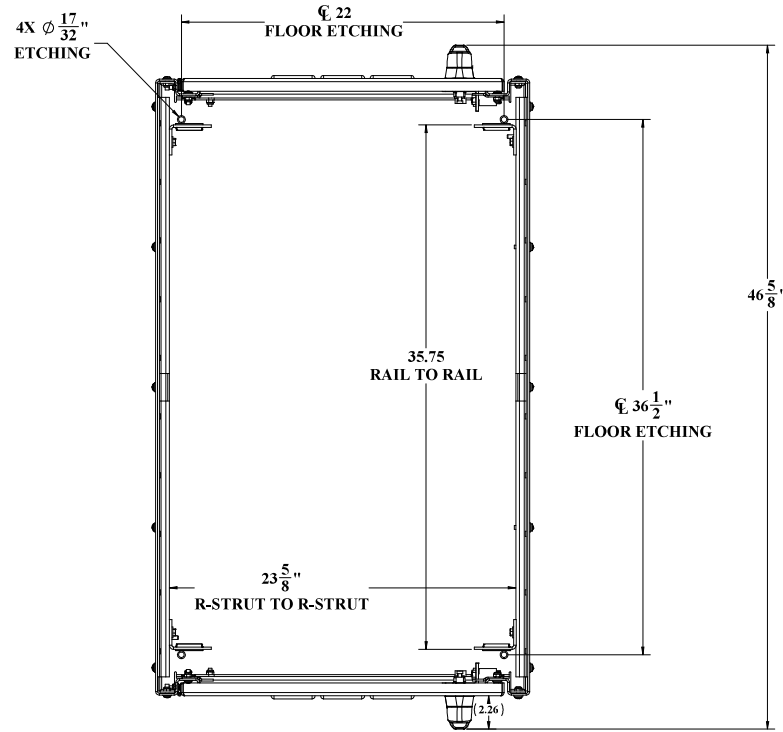

TOP VIEW CEILING AND ALUMASHIELD NOT SHOWN

WEB DRAWING (NOT FOR FABRICATION)

UNLESS OTHERWISE SPECIFIED:		NAME	DATE	DDB Unlimited Inc.			
CONVERSION: AS OF PICTURE		Model by:	0508	OD Family Enclosures			
APPROVAL:	2/1/18	Drawn by:	Max-ws	OD Family Enclosure, DDX, Closed			
REVISED AND CORRECTED:	2/1/18	Sales-Rep/rev	Complete	14/16/18	REV		
FOR APPROVAL:	2/1/18	Q.A. Appr:	189	01/08/19	REV		
FOR CONSTRUCTION:	2/1/18	Prod.Mgr:	Ch665	09/10/19	D	38515	00428
FOR FIELD USE:	2/1/18				C		
FOR ARCHIVE:	2/1/18						
FOR LEGAL:	2/1/18						
FOR MARKETING:	2/1/18						
FOR TRAINING:	2/1/18						
FOR SUPPORT:	2/1/18						
FOR COMPLIANCE:	2/1/18						
FOR OTHER:	2/1/18						
MATERIAL: SPRINKLER ENCLOSURE				SCALE:	1:32	WEIGHT:	
PARTS: WWW.DDBUNLIMITED.COM				Sheet Number:	2		
DO NOT SCALE DRAWING							
							SHEET 2 OF 3

THE INFORMATION CONTAINED IN THIS DRAWING IS THE SOLE PROPERTY OF DDB Unlimited, INC. ANY REPRODUCTION IN PART OR AS A WHOLE WITHOUT THE WRITTEN PERMISSION OF DDB Unlimited, INC. IS PROHIBITED.

DDB FORM 7.1-2 REV.F 02/11/19

WEB DRAWING (NOT FOR FABRICATION)

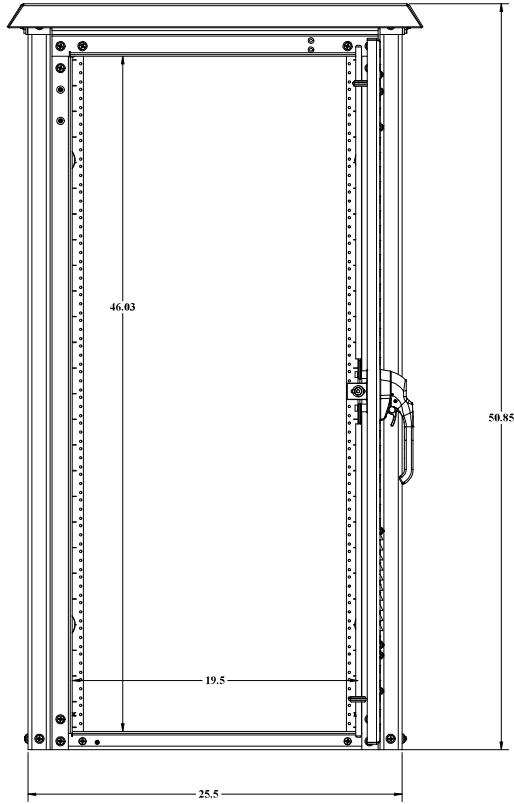

BACK VIEW GASKET NOW SHOWN

WEB DRAWING (NOT FOR FABRICATION)

UNLESS OTHERWISE SPECIFIED:		NAME	DATE	DDB Unlimited Inc.			
DIMENSIONS ARE IN INCHES	Model No.:	0008	03/22/14	OD Family Endusers			
APPROVAL	Drawn By:	Manoel	03/04/13	Echoville, OD, 50, 20X			
FOR CONSTRUCTION	Checked By:	Manoel	03/04/13				
FOR PURCHASE	Third Party Approval:						
FOR INSTALLATION	Sales Representative:	Compton	11/06/11				
FOR DELIVERY	Q.A. Appr.:	189	01/08/13	REV	Cage Code:	DWG. NO.:	REV
	Prof. Mgr.:	Chaves	03/31/10	D	38515	00428	C
MATERIAL: SPRING-4-EDGE-20042	Created By:			SCALE: 1:32 WEBSITE: SHEET 3 OF 3			
FAINSZ: www.voss-ir.com	DO NOT SCALE DRAWING						