

WEB DRAWING (NOT FOR FABRICATION)

REVISIONS		
REV.	DESCRIPTION	DATE
A	Initial Release per DR-00971	5/28/2014
B	UPDATE TO NEW FORMAT	11/25/2020

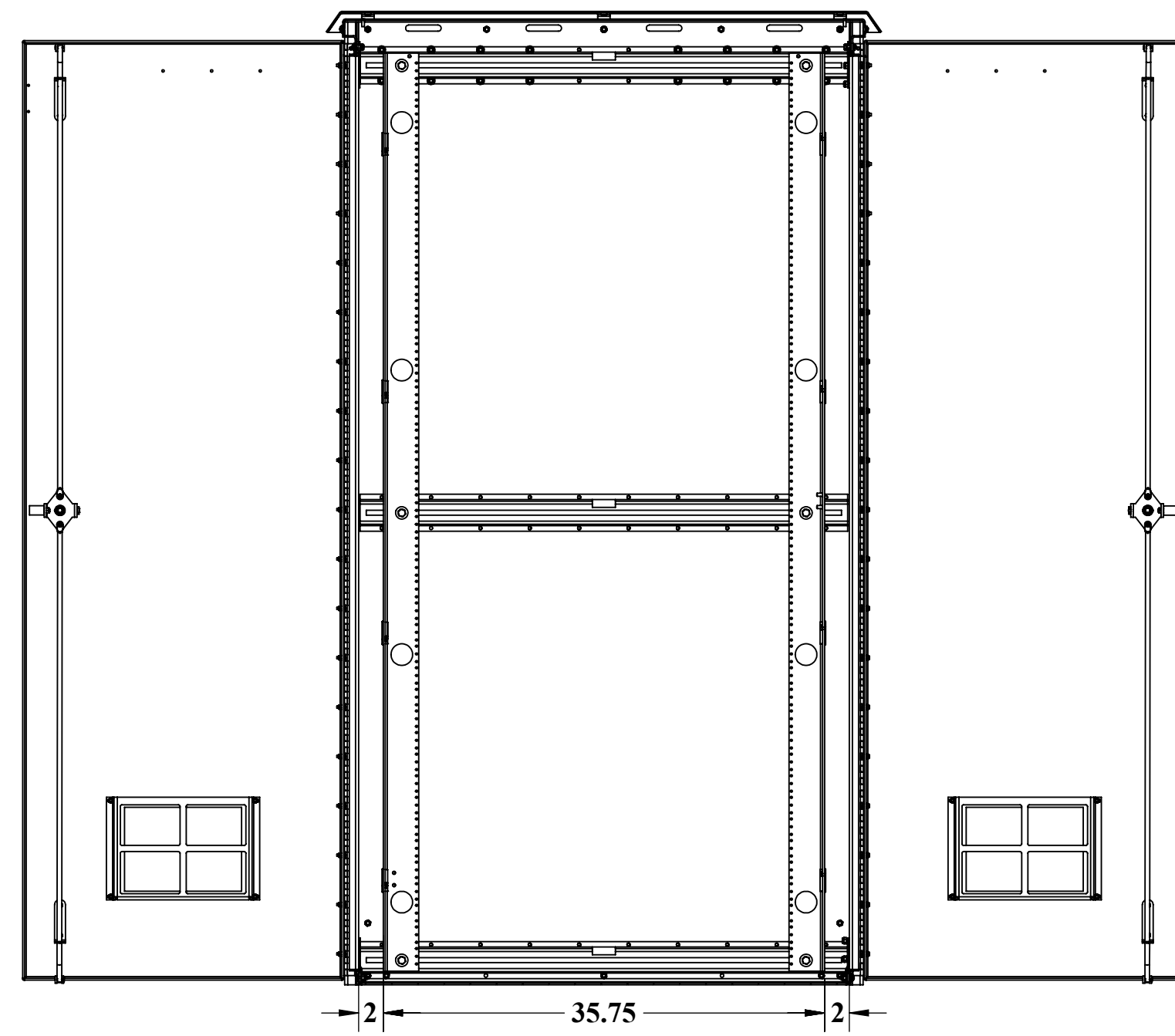

SECTION A-A
SCALE 1 : 12

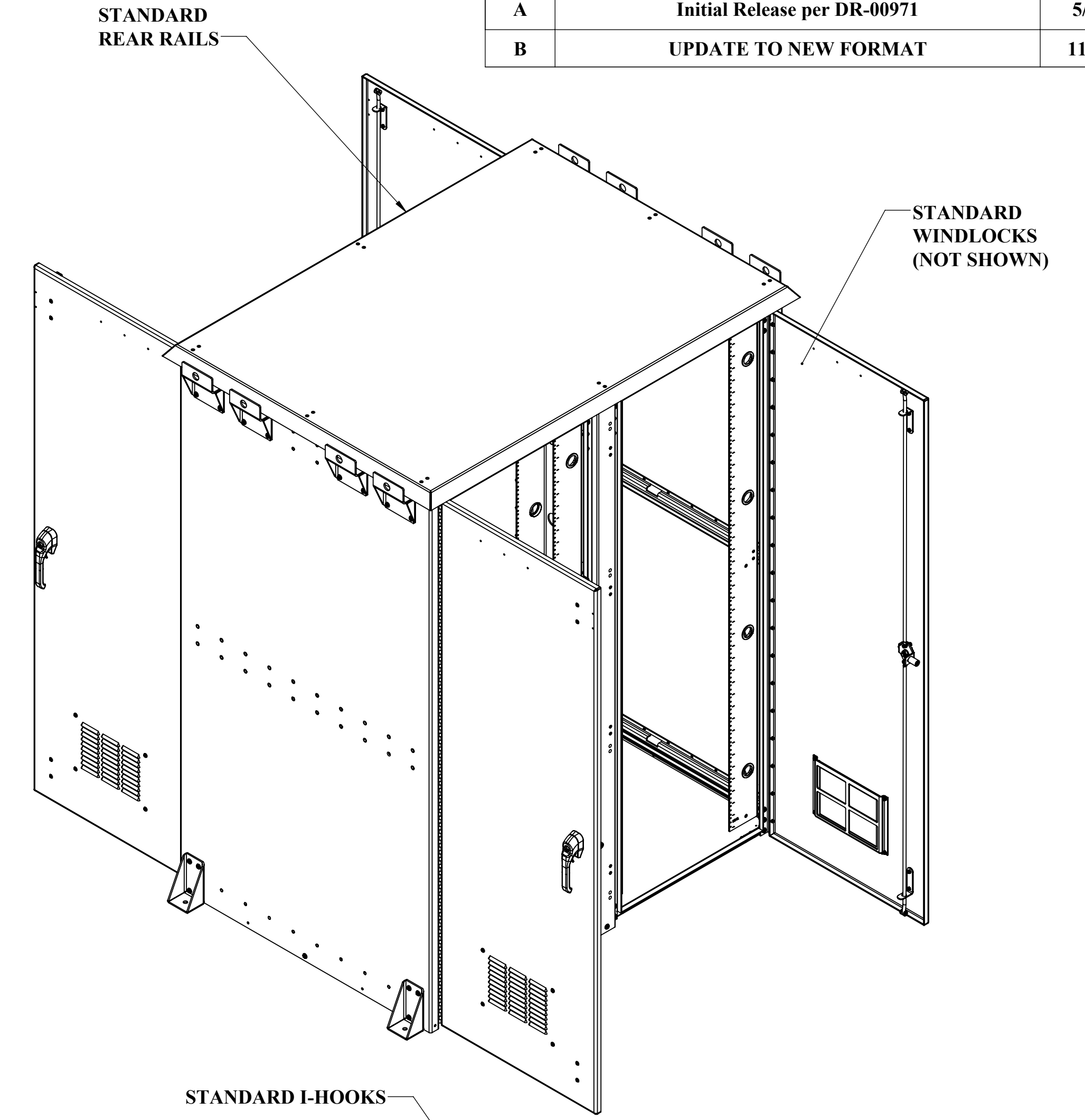
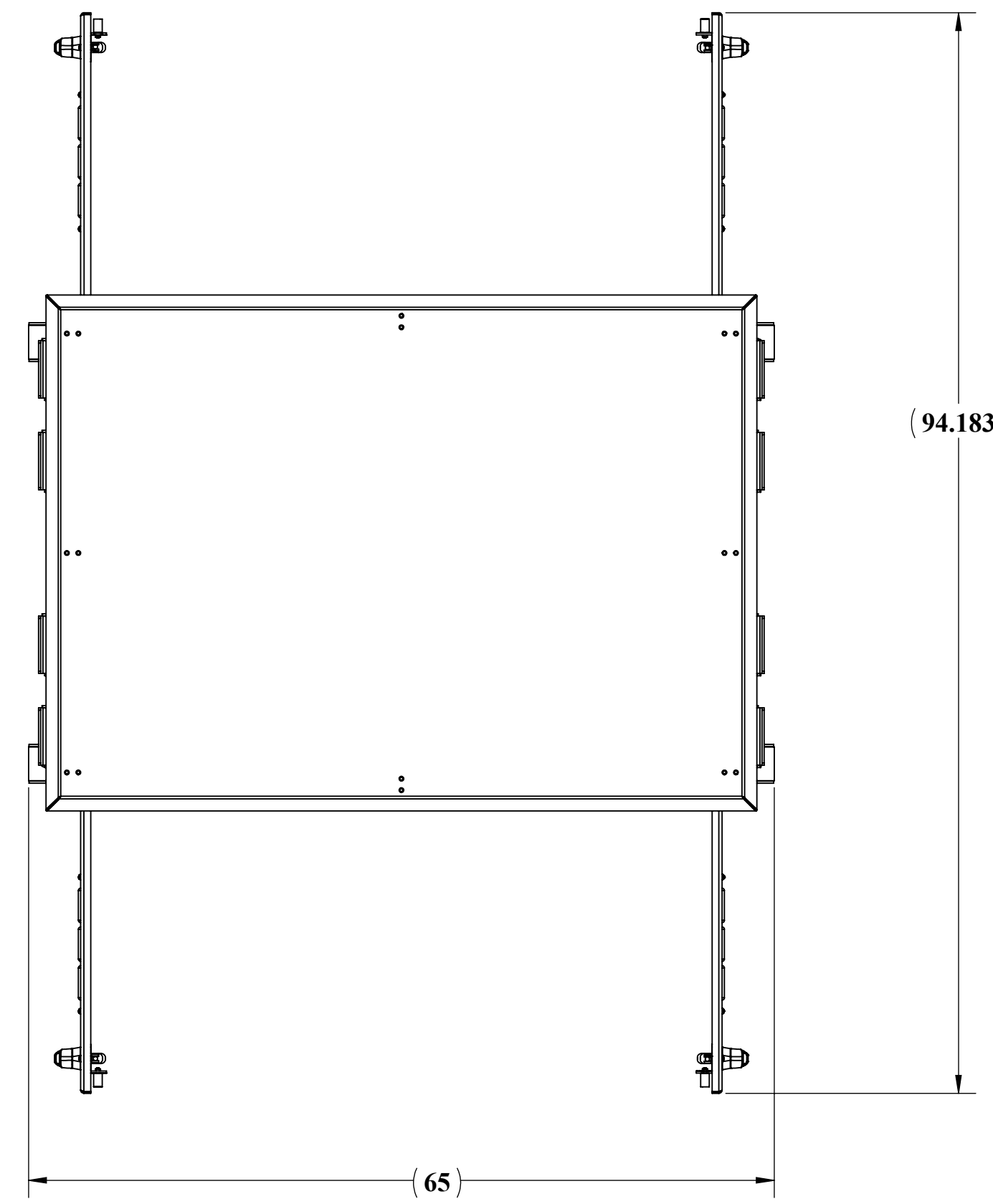
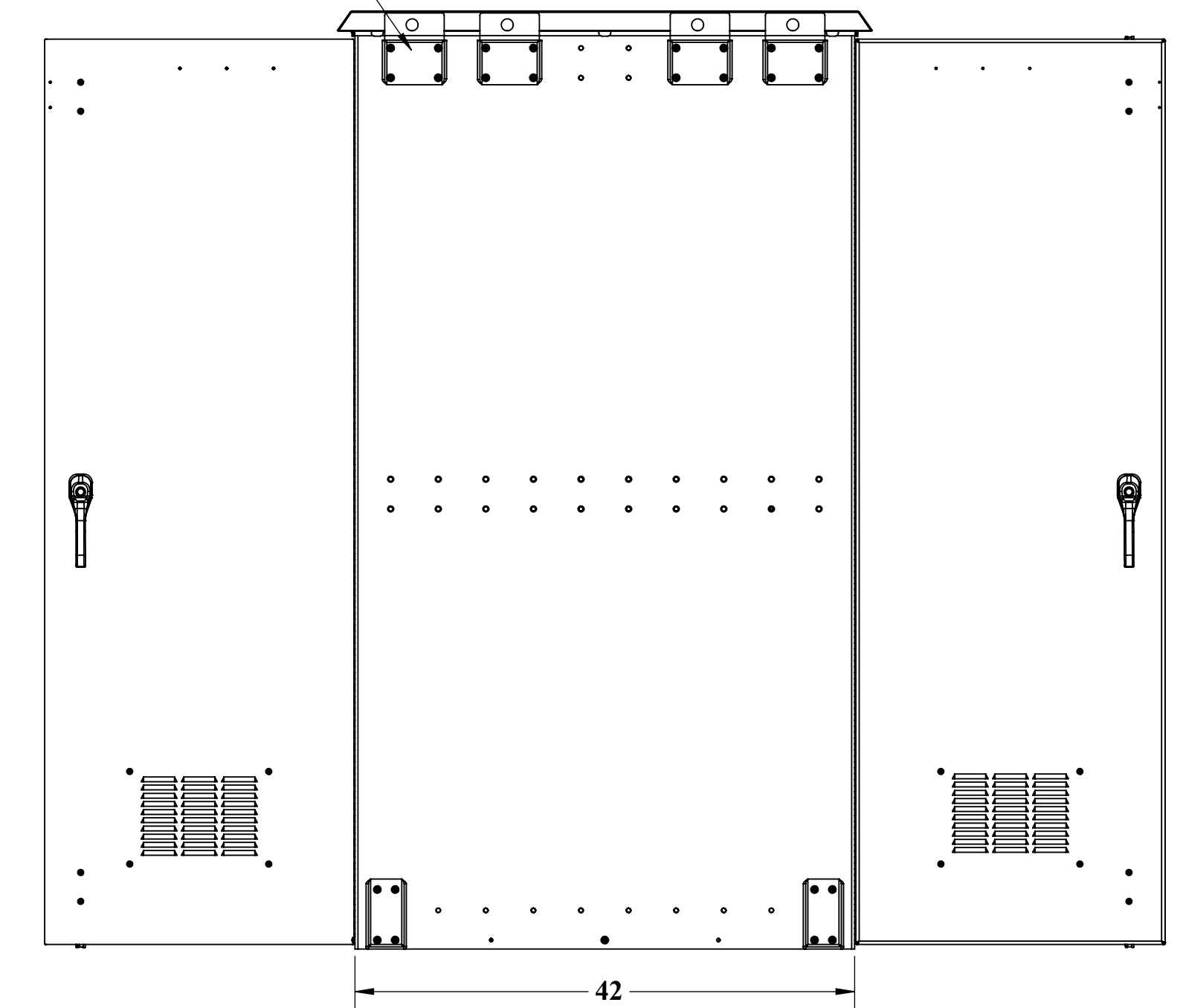
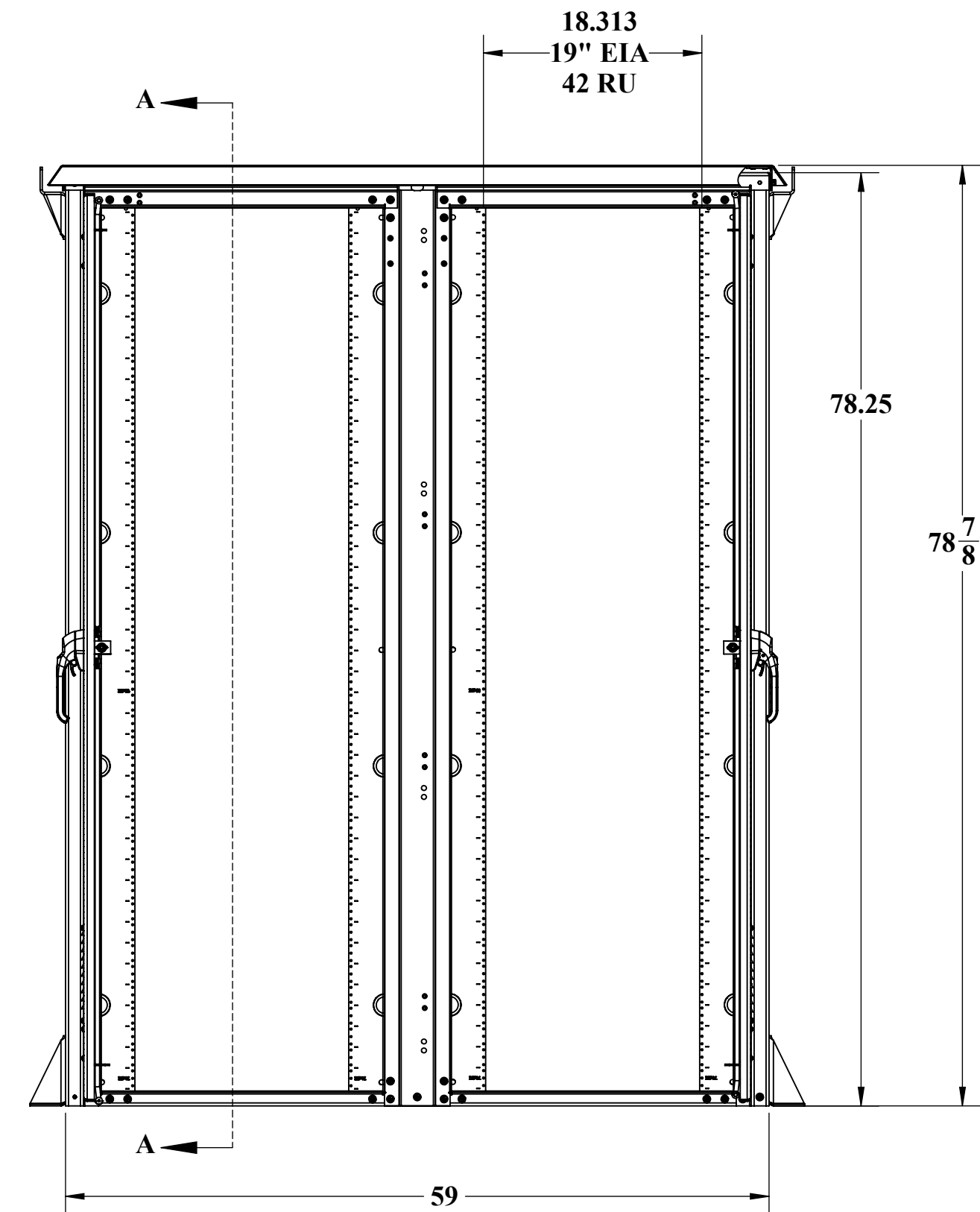

WEB DRAWING (NOT FOR FABRICATION)

UNLESS OTHERWISE SPECIFIED:		NAME	DATE	DDB Unlimited Inc.			
DIMENSIONS ARE IN INCHES		Model by:	DDB	20D-XXXX			
ANGULAR:	±1°	Drawn by:	EdwardW	DWG, WEB, 20D, 78, DDX			
FRACTIONAL/NO DECIMAL:	±0.1250	Sales.Rep.:	roy	SIZE	Cage Code:	DWG. NO.:	REV
ONE PLACE DECIMAL:	±0.0625	Q.A.Appr.:	ClarkK	D	385Y5	00971	B
TWO PLACE DECIMAL:	±0.03125	Prod.Mgr.:	ClarkK	SCALE: 1:8	WEIGHT: 489 lbs.	SHEET 1 OF 3	
THREE PLACE DECIMAL:	±0.015625	Control Number:					
ALL HOLES: ±0.0010							
MATERIAL: 5052-H32-0.125 ASTM B209-04	MATERIAL THICKNESS IS: 0.125"						
PAINT: DIAMOND VORDEL BRIDGE GLOSS TEXTURE ET-4028							
DO NOT SCALE DRAWING							

WEB DRAWING (NOT FOR FABRICATION)

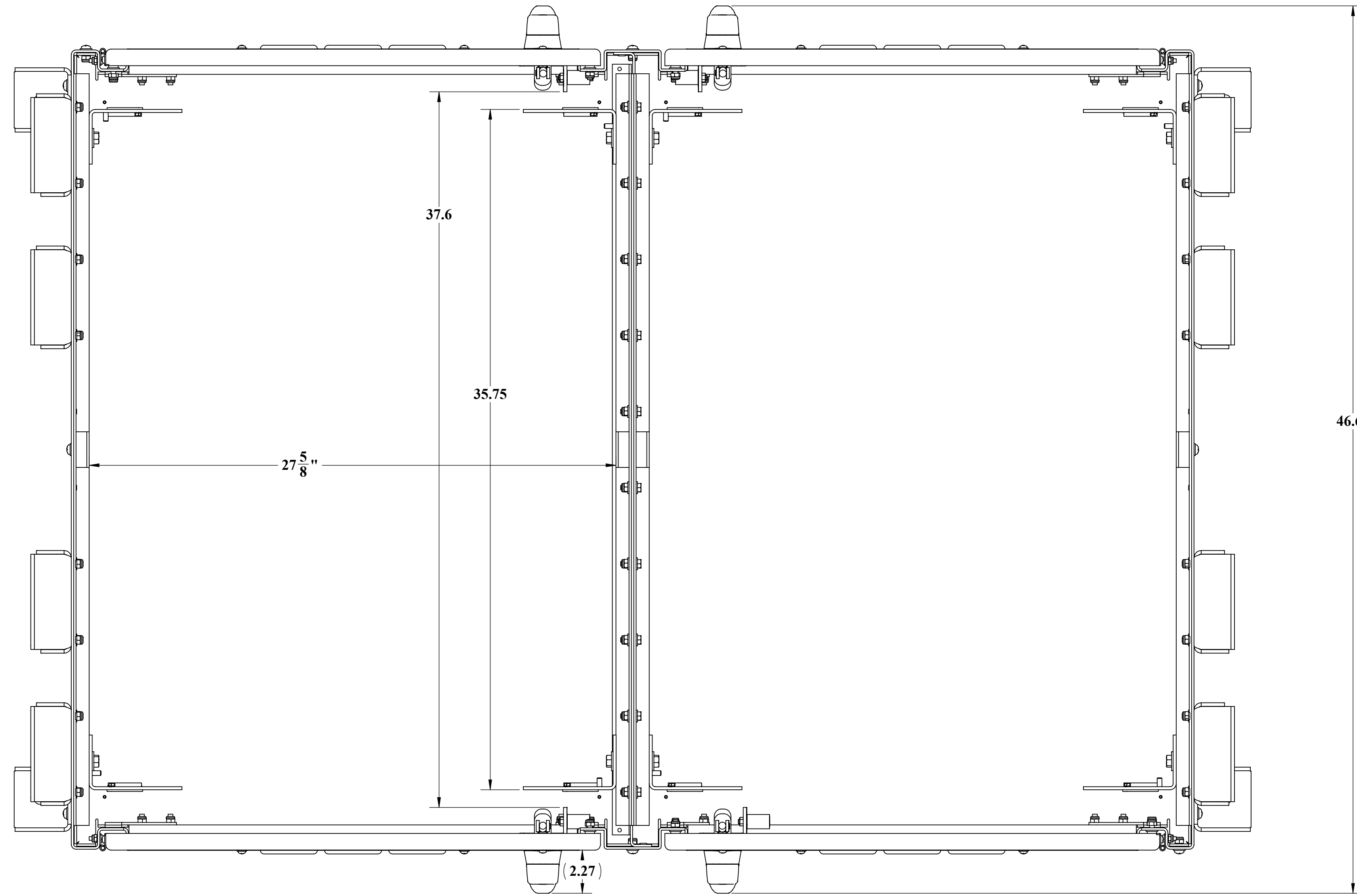

TOP VIEW CEILING AND SOLAR SHIELD NOT SHOWN

WEB DRAWING (NOT FOR FABRICATION)

UNLESS OTHERWISE SPECIFIED:		NAME	DATE	DDB Unlimited Inc.			
DIMENSIONS ARE IN INCHES				20D-XXXX			
ANGULAR:	±1°	Model by:	DDB	6/4/2014			
FRACTIONAL/NO DECIMAL:	±0.1250	Drawn by:	EdwardW	06/04/14			
ONE PLACE DECIMAL:	±0.0625	Sales.Rep.:		SIZE	Cage Code:	DWG. NO.:	REV
TWO PLACE DECIMAL:	±0.03125	Q.A. Appr.:	tray	D	385Y5	00971	B
THREE PLACE DECIMAL:	±0.015625	Prod.Mgr.:	ClarkK	11/30/20			
ALL HOLES: ±0.0010		Control Number:		SCALE: 1:8	WEIGHT: 281 lbs.	SHEET 2 OF 3	
MATERIAL: 5052-H32-0.125 ASTM B209-04							
PAINT: BRANSON VOGEL-BRIDGE GLOSS TEXTURE ET-4308							
DO NOT SCALE DRAWING							

UNCLASSIFIED PUBLIC

DDB FORM: 7-1-2 REV.F 05/02/19

WEB DRAWING (NOT FOR FABRICATION)

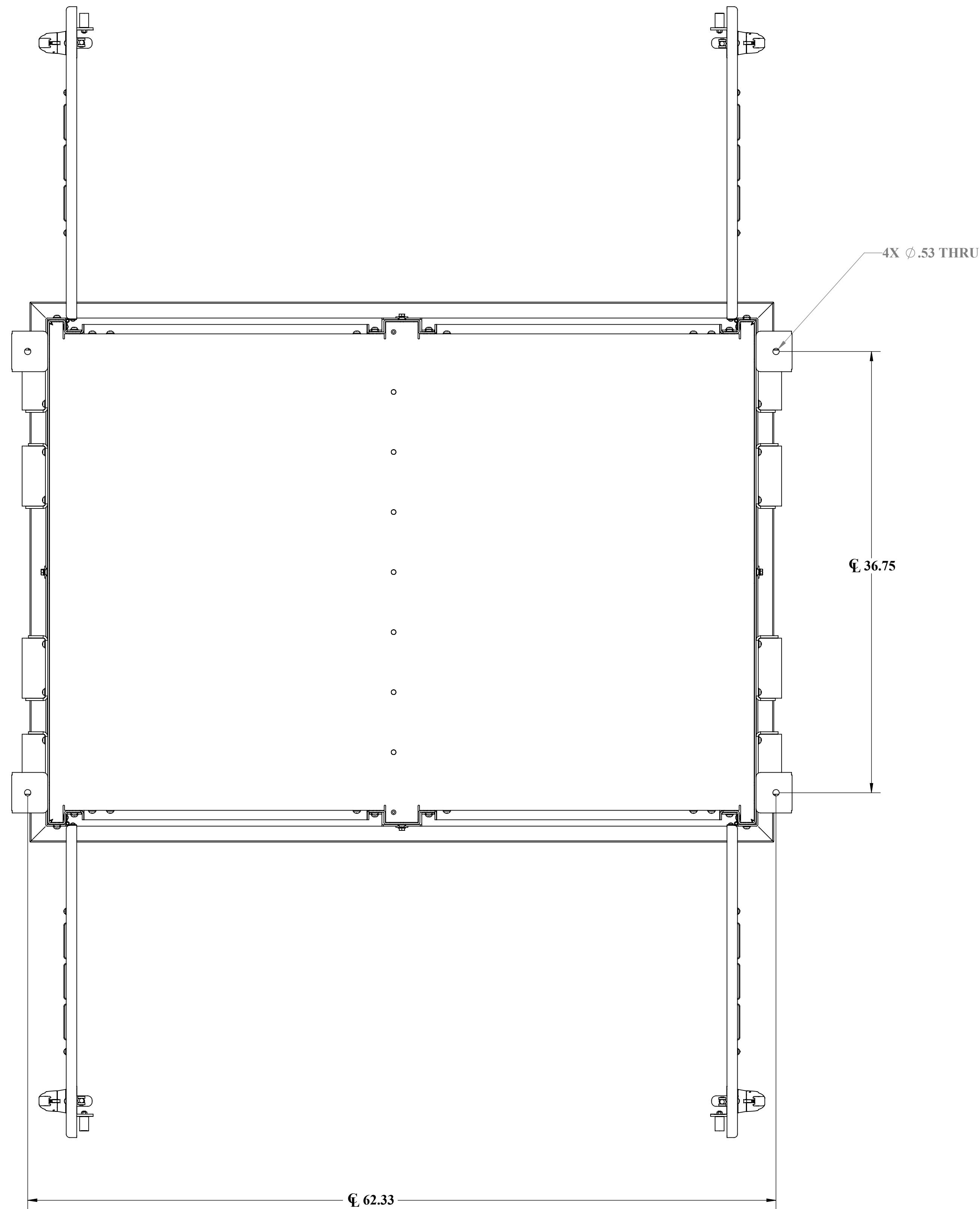

BOTTOM VIEW MOUNTING HOLE LOCATIONS

WEB DRAWING (NOT FOR FABRICATION)

UNLESS OTHERWISE SPECIFIED:		NAME	DATE	DDB Unlimited Inc.		
DIMENSIONS ARE IN INCHES		Model by:	DDB	6/4/2014	20D-XXXX	
ANGULAR:	±1°	Drawn by:	EdwardW	06/04/14	DWG, WEB, 20D, 78, DDX	
FRACTIONAL/NO DECIMAL:	±0.1250	Sales.Rep.:	tray	11/30/20	SIZE	Cage Code:
ONE PLACE DECIMAL:	±0.0625	Prod.Mgr.:	ClarkK	11/30/20	D	385Y5
TWO PLACE DECIMAL:	±0.03125	Control Number:			DWG. NO.:	00971
THREE PLACE DECIMAL:	±0.015625				REV	B
ALL HOLES ±0.0010					SCALE: 1:8	WEIGHT: 489 lbs.
MATERIAL: 5052-H32-0.125 ASTM B209-04					SHEET 3 OF 3	
PAINT: DIAMOND VOGEL, BEIGE GLOSS TEXTURE ET-4328						
DO NOT SCALE DRAWING						