

WEB DRAWING (NOT FOR FABRICATION)

REVISIONS		
REV.	DESCRIPTION	DATE
A	Initial Release per DR-00987	5/28/2014
B	UPDATED FORMAT	12/10/2020

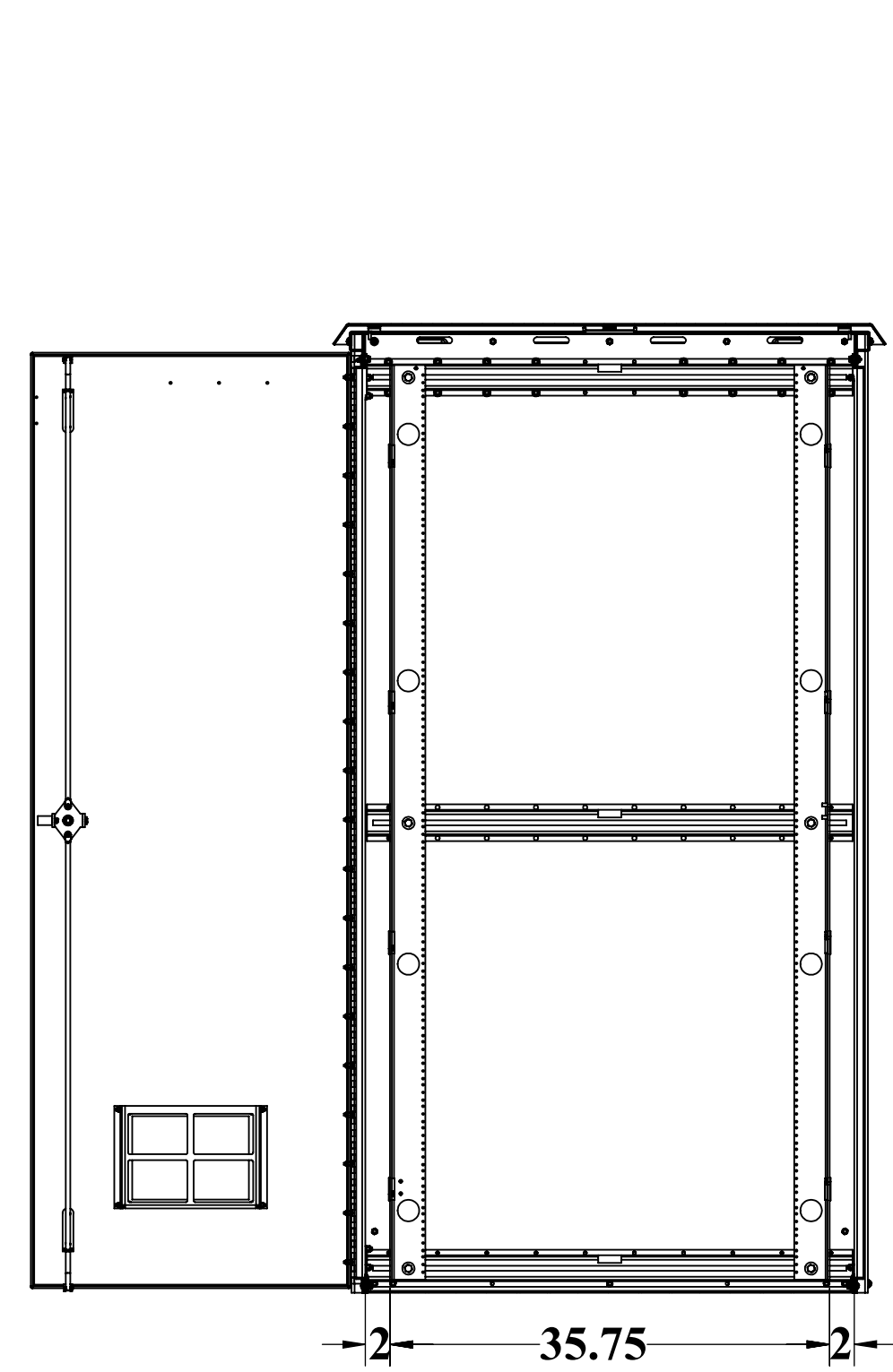

SECTION A-A
SCALE 1:14

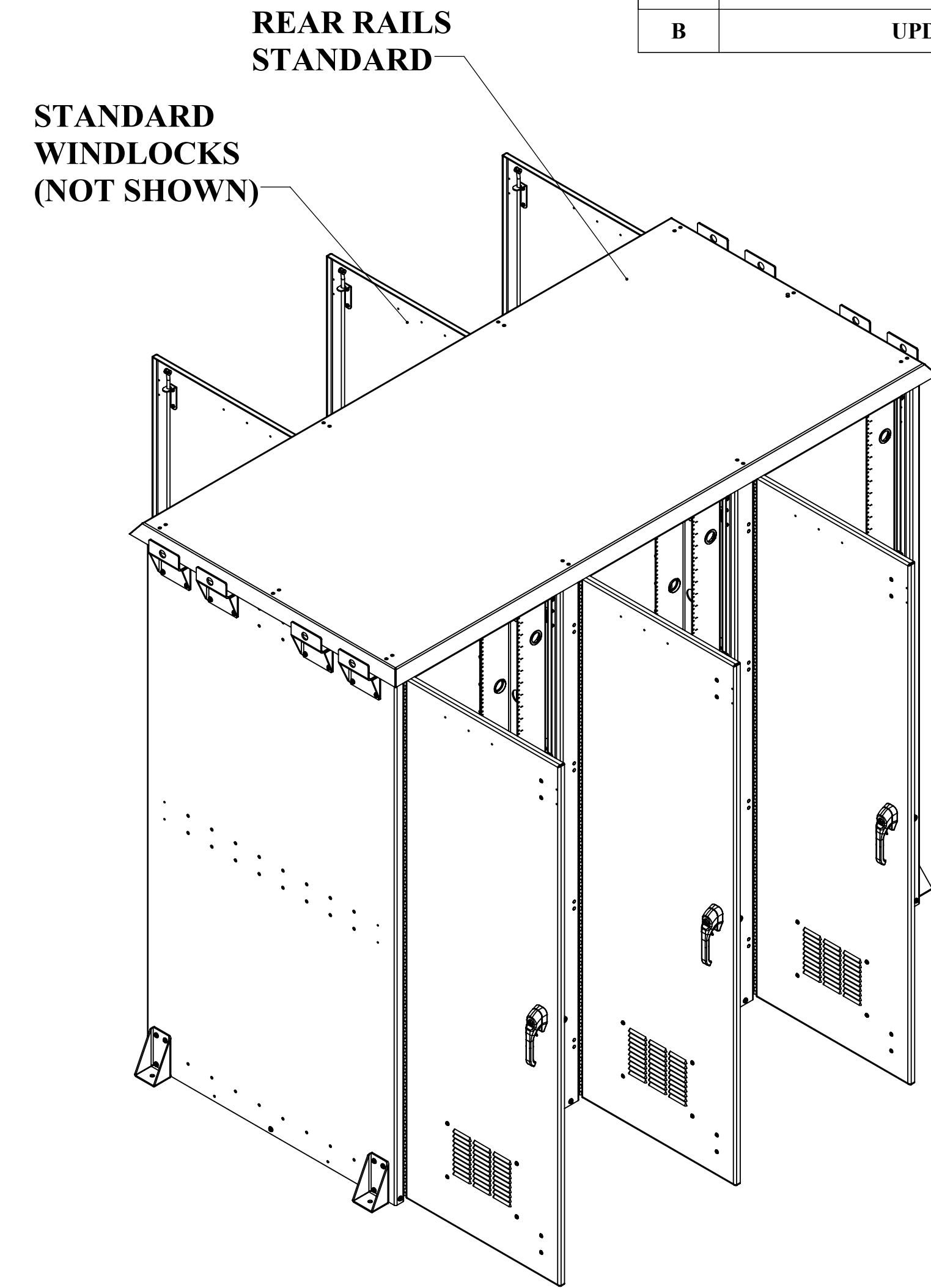
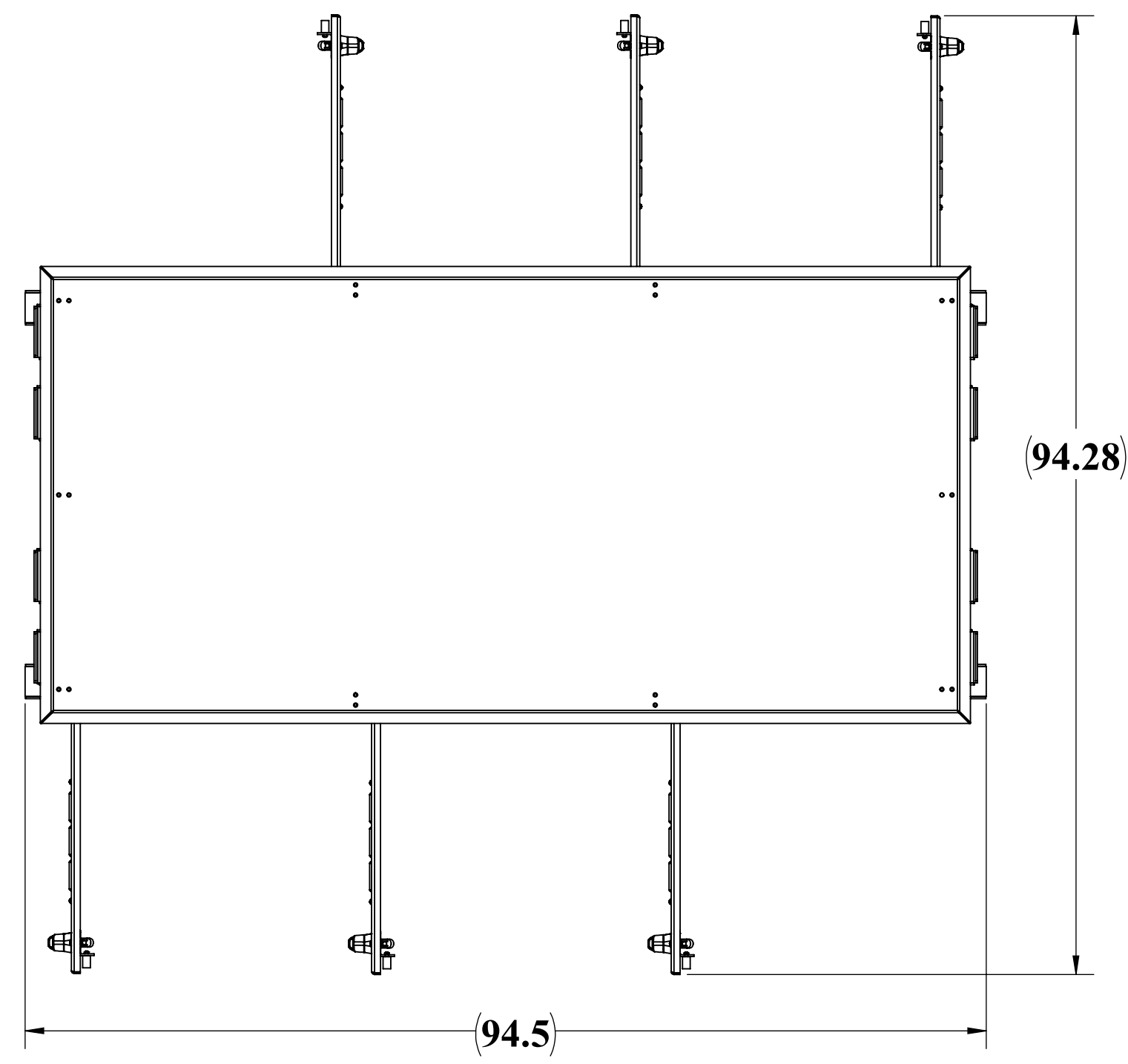
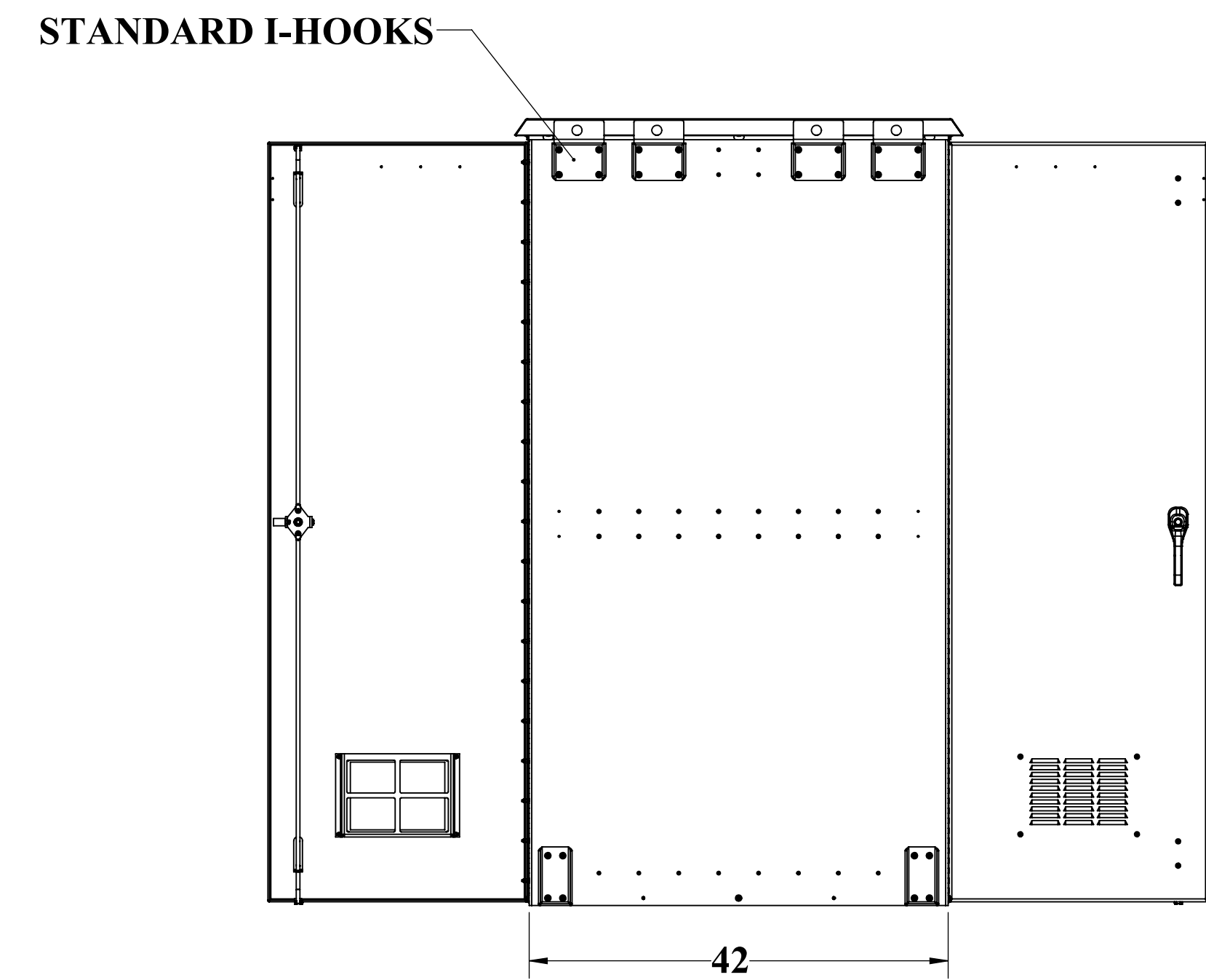
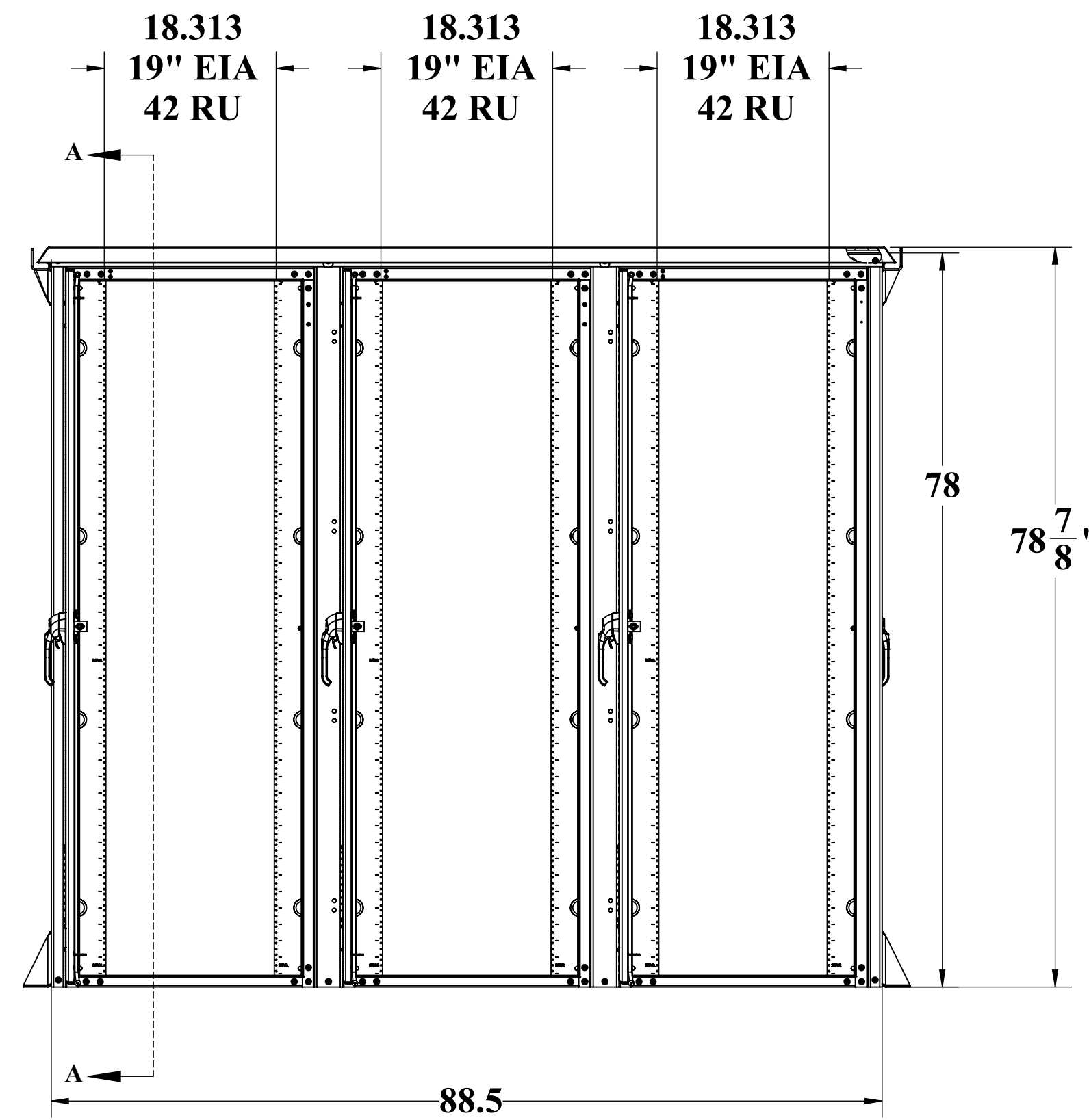

WEB DRAWING (NOT FOR FABRICATION)

UNLESS OTHERWISE SPECIFIED:		NAME	DATE	DDB Unlimited Inc.				
DIMENSIONS ARE IN INCHES				30D-XXXX				
ANGULAR:	±1°	Model by:	DDB	6/4/2014	DWG. 30D, 78, DDX			
FRACTIONAL/NO DECIMAL:	±0.1250	Drawn by:	EdwardW	06/13/14	SIZE	Cage Code:	DWG. NO.:	REV
ONE PLACE DECIMAL:	±0.0625	Sales.Rep.:			D	385Y5	00987	B
TWO PLACE DECIMAL:	±0.03125	Q.A.Appr.:	tray	12/11/20	SCALE: 1:8	WEIGHT: 694 lbs.	SHEET 1 OF 3	
THREE PLACE DECIMAL:	±0.015625	Prod.Mgr.:	ClarkK	12/11/20				
ALL HOLES ±0.0010		Control Number:						
MATERIAL: 5032-H32N.125-ASTM B209-04		Control Number:						
PAINT: Diamond Vogel Ridge Clear Textures ET-8239		Control Number:						
DO NOT SCALE DRAWING		Control Number:						

WEB DRAWING (NOT FOR FABRICATION)

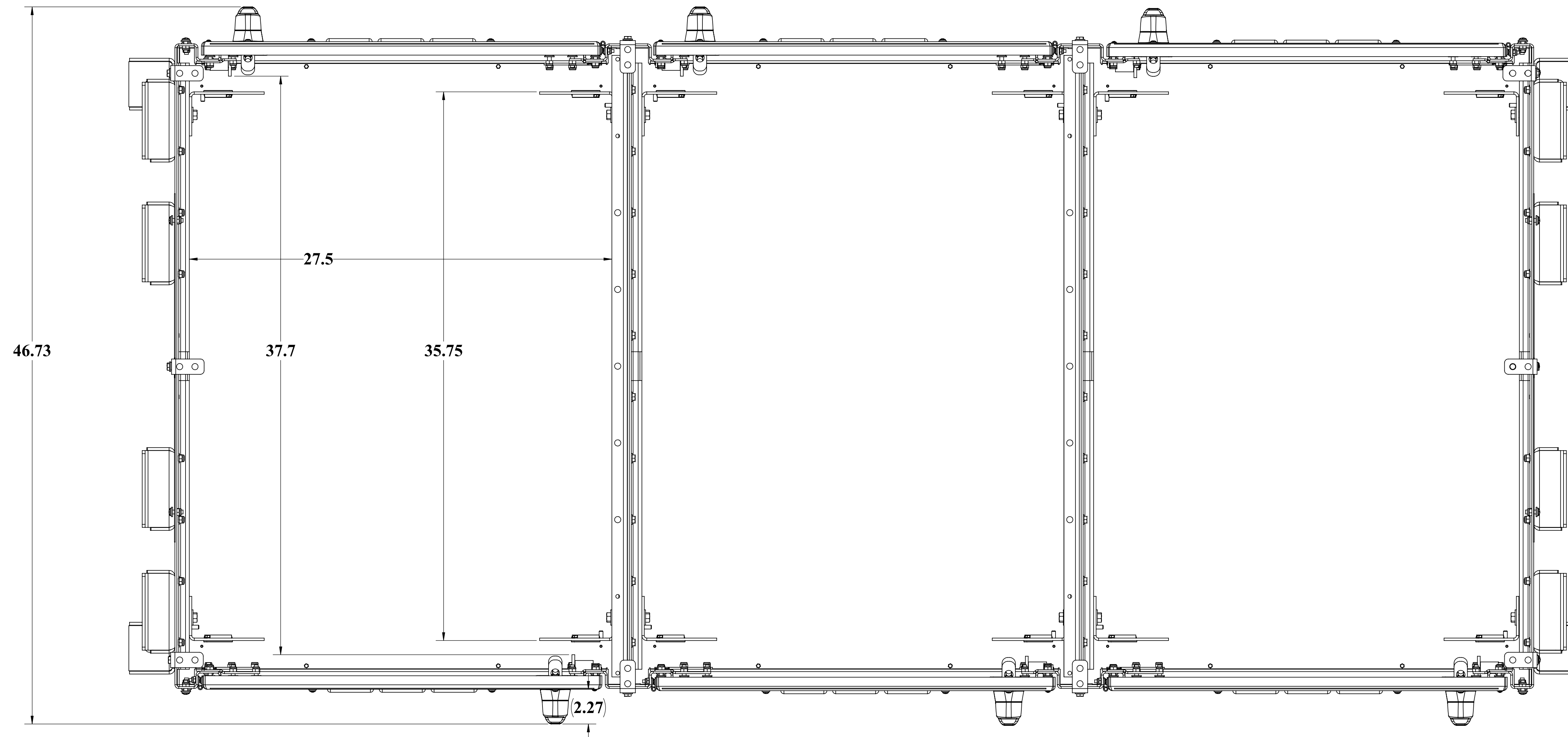

TOP VIEW SOLAR SHIELD AND CEILING NOT SHOWN

WEB DRAWING (NOT FOR FABRICATION)

UNLESS OTHERWISE SPECIFIED:			
DIMENSIONS ARE IN INCHES			
ANGULAR:	±1°		
FRACTIONAL NO. DECIMAL:	±0.1250		
ONE PLACE DECIMAL:	±0.0625		
TWO PLACE DECIMAL:	±0.0313		
THREE PLACE DECIMAL:	±0.0156		
ALL HOLES: ±0.0031			
MATERIAL: 5032-432N0.125-ASTM B209-04			
PAINT: Diamond Vogel Beige Gloss Texture ET-8320			
DO NOT SCALE DRAWING			
DDB Unlimited Inc.		DDX Closed	
DWG. 30D, DOORS CLOSED			
SIZE	Cage Code:	DWG. NO.:	REV
D	385Y5	00987	B
SCALE: 1:8		WEIGHT: 678 lbs.	SHEET 2 OF 3

UNCLASSIFIED PUBLIC
 THE INFORMATION CONTAINED IN THIS DRAWING IS THE SOLE PROPERTY OF DDB Unlimited, INC. ANY REPRODUCTION IN PART OR AS A WHOLE WITHOUT THE WRITTEN PERMISSION OF DDB Unlimited, INC. IS PROHIBITED.

WEB DRAWING (NOT FOR FABRICATION)

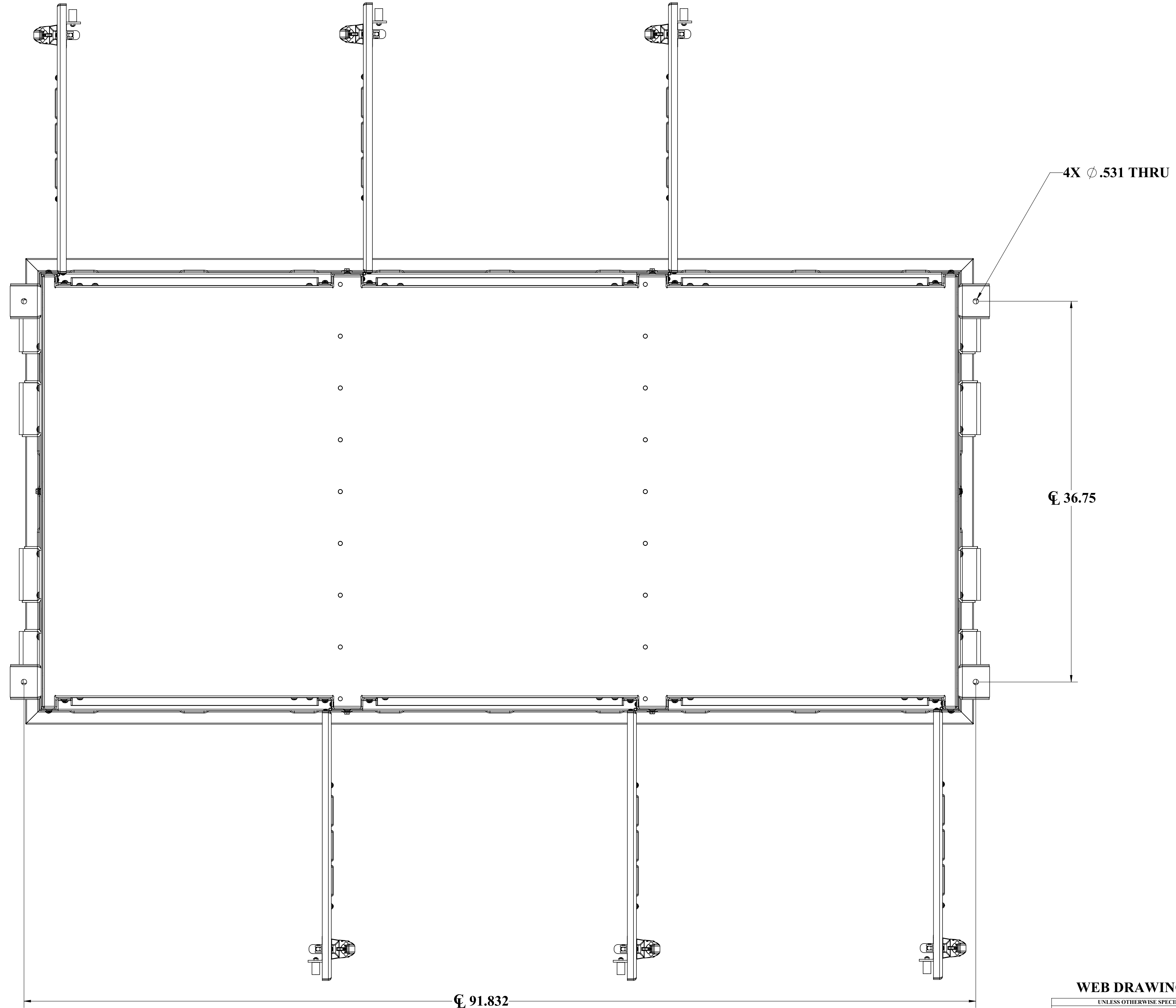

91.832

36.75

4X Ø.531 THRU

MOUNTING HOLES

WEB DRAWING (NOT FOR FABRICATION)

UNLESS OTHERWISE SPECIFIED:			
DDB Unlimited Inc.			
30D-78DDX			
DWG. NO.: 00987			
SIZE	Cage Code:	DWG. NO.:	REV
D	385Y5	00987	B
MATERIAL: 5032-H32N0.125-ASTM B209-04		SCALE: 1:8	
PAINT: Diamond Vogel Beige Gloss Texture ET-8320		WEIGHT: 694 lbs.	
DO NOT SCALE DRAWING		SHEET 3 OF 3	

DDB FORM: 7.1-2-REV:K 08/02/17